

## SERRANDA AVVOLGIBILE TUBONDA – SEMPLICE E RINFORZATA

### Descrizione prodotto

Serranda a maglia ondulata Tubonda Semplice costituita da 2 tubi ondulati  $\varnothing 14$  sagomati per formare dei rombi uniti tra loro da fascette stampate. La serranda modello Tubonda Rinforzata ha in aggiunta un tubo diritto dello stesso diametro posizionato centralmente al rombo.

Scorrimento verticale e ad avvolgimento superiore.

Zoccolo inferiore standard h. 485 mm, composto da 3 elementi ciechi ed elemento spiaggiabile completo di maniglie e tamponamenti di battuta. Nella parte superiore sono previsti 2 oppure 3 elementi ciechi necessari per l'avvolgimento all'albero.

Può essere utilizzata come "inserto per aerazione" sulle serrande avvolgibili cieche passo 115.

Serranda conforme alla normativa UNI EN 13241-1 

Le serrande soggette all'azione del vento, ad esempio nel caso di installazione in facciata, devono essere conformi almeno alla classe 2 della EN 12424.

### Caratteristiche e materiali

Tubo		$\varnothing 14 \times 1,2$	$\varnothing 14 \times 1,5$	$\varnothing 14 \times 1,2$
Materiale		Acciaio zincato	Alluminio	Acciaio Inox AISI 304
Peso manto – Modello Tubonda Semplice	[kg/m <sup>2</sup> ]	11,00	3,60	11,00
Peso manto – Modello Tubonda Rinforzata	[kg/m <sup>2</sup> ]	16,00	4,80	16,00
Larghezza massima consigliata	[m]	9,00	9,00	4,00
Luoghi di utilizzo		Negozii - Varie		

### Ingombri

Gli ingombri sono indicativi – per maggiori dettagli contattare il nostro Ufficio Tecnico.

Nel caso di funzionamento con albero rotante il minimo ingombro verticale è pari a 500 mm, dato dall'ingombro del motore e dei relativi supporti.

Nel caso di serranda Tubonda Semplice con tubo in acciaio zincato o Inox AISI 304 con albero a molle o ottagonale D.70 fare riferimento alla tabella di seguito riportata; per valori degli ingombri relativi agli altri materiali contattare il nostro Ufficio Tecnico.



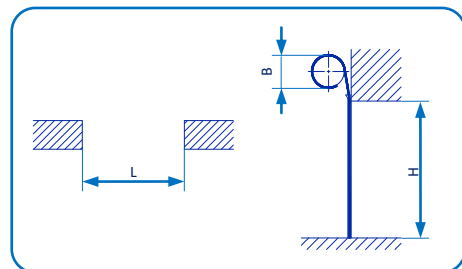
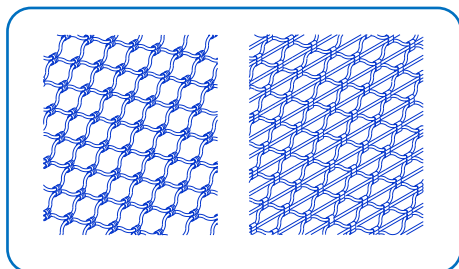

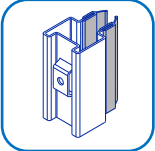
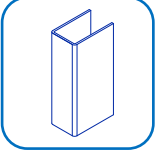
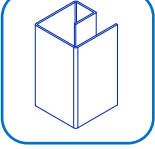

H Altezza	B - Diametro rotolo serranda avvolta																					
	Albero a molle										Albero ottagonale D. 70 con adattatore D. 133											
	380	380	380	380	400	400	400	400	-	-	-	-	-	-	350	350	-	-	-	-	-	-
5000	380	380	380	380	400	400	400	400	-	-	-	-	-	-	350	350	-	-	-	-	-	-
4500	370	370	370	370	395	395	395	395	395	-	-	-	-	-	340	340	-	-	-	-	-	-
4000	360	360	360	360	360	380	380	380	380	380	380	-	-	-	330	330	330	-	-	-	-	-
3500	340	340	340	340	340	340	365	365	365	365	365	375	375	-	300	300	300	300	-	-	-	-
3000	320	320	320	320	320	320	350	350	350	350	350	350	350	370	280	280	280	280	-	-	-	-
2500	310	310	310	310	310	310	335	335	335	335	335	335	335	335	270	270	270	270	270	-	-	-
2000	280	280	280	280	280	280	320	320	320	320	320	320	320	320	250	250	250	250	250	250	-	-
	1500	2000	2500	3000	3500	4000	4500	5000	5500	6000	6500	6750	7000	7500	1500	2000	2500	3000	3500	4000	4500	5000
	L - Larghezza luce																					

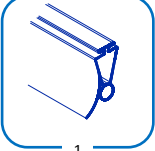
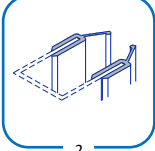
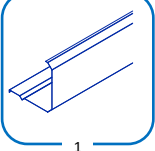
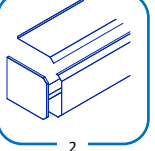
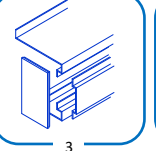
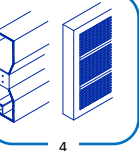

## Guide di scorrimento

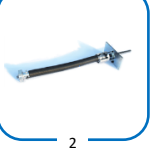
<p>Guida sagomata 60x50 in acciaio zincato spessore 2,0 mm Con guarnizioni per posa in luce e oltreluce per tutte le larghezze</p>	
<p>Guide a U in acciaio zincato spessore 1,5 mm - 40 x 22 x 40 per Larghezze fino a 2500 mm - 40 x 25 x 40 per Larghezze fino a 4400 mm - 50 x 25 x 50 per Larghezze fino a 5600 mm - 70 x 27 x 70 per Larghezze fino a 7500 mm</p>	
<p>Guide a G in acciaio zincato spessore 2,0 mm - 60 x 60 – 80 x 60 – 80 x 80 – 100 x 80 - per serrande con diametro di avvolgimento superiore a 450 mm - per posa oltre luce fronte muro</p>	

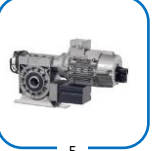
## Accessori

<b>Antirumore</b>	
<ol style="list-style-type: none"> <li>Gomma di battuta applicata su spiaggia</li> <li>Guarnizione in PVC per guide</li> </ol>	 
<b>Coperture</b>	
<ol style="list-style-type: none"> <li>Top frontale</li> <li>Cassonetti interi formati da top frontale, top superiore e fondelli</li> <li>Cassonetti con frontale asportabile per ispezione esterne</li> <li>Velette in lamiera pressopiegata o costituita da elementi P.115 ciechi o microforati</li> </ol>	   
<b>Funzionamenti</b>	
<ol style="list-style-type: none"> <li>Funzionamento manuale con albero a molle Tubo tondo Ø 48 – 60 – 76 – 89 – 101</li> <li>Funzionamento manuale con molla torsionale Tubo ottagonale zincato 70 – 102</li> <li>Motore assiale per albero a molle Tubo tondo Ø 48 – 60 – 76 – 89 – 101</li> <li>Motore tubolare con o senza manovra di soccorso Tubo ottagonale zincato 70</li> <li>Motore laterale a presa diretta o rinvio a catena per alberi rotanti Ø 133 – 159 – 193 – 219 – 244 – 273 – 323 – 406</li> <li>Motore Forza automatico Tubo ottagonale zincato 70 - 102</li> </ol>	     

## Finiture

Verniciatura a fuoco RAL Standard					
1000	Beige verde	7004	Grigio segnale F14	8017	Marrone cioccolato
1001	Beige	7016	Grigio antracite	8019	Marrone grigio
1013	Bianco Perla	7021	Grigio scuro	8024	Marrone beige
1015	Avorio chiaro	7024	Grigio grafite	9001	Bianco crema
6005	Verde muschio	7040	Grigio finestra	9002	Bianco grigio
6009	Verde abete	7046	Grigio Tel. 2	9005	Nero profondo
6015	Oliva scuro	7047	Grigio Tel. 4	9010	Bianco puro
6019	Verde bianco	8004	Marrone rame	9011	Nero grafite
6023	Verde menta	8011	Marrone noce	9016	Bianco traffico
7000	Grigio vaio	8014	Marrone seppia		
7001	Grigio argento	8016	Marrone mogano		

Verniciatura a fuoco Speciali	
RAL 9006	Grigio Arsonsisi
Gialli / Rossi / Blu	Nero Raggrinzante Metallizzato
Bianco: Marmo (liscio) - Marmo antico (ruvido)	Nero / Marrone: Sabbia (ruvido)
Grigio: Marmo (liscio) - Marmo antico (ruvido)	Sabbia 900
Marrone: Marmo (liscio) - Marmo antico (ruvido)	Canna di Fucile
Verde: Marmo (liscio) - Marmo antico (ruvido)	Oro per esterni
Rosso: Marmo (liscio)	Marrone Martellato per esterni

Ossidazione per serrande in alluminio											
											
F01	F02	F03	F04	F05	F06	F07	F08	F09	F10	F11	F12

## La gamma completa delle serrande

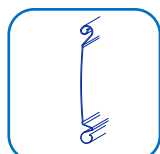

Cieca P.115



Microforata P.115

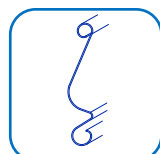

Cieca P.97



Microforata P.97

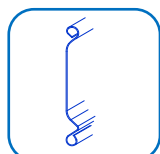

Cieca P.73

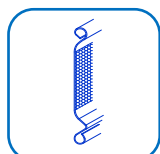

Microforata P.73

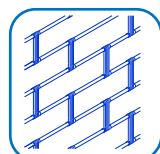

Tubolare P.120

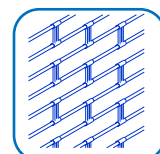

Tubolare P.95

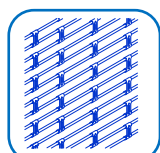

Tubolare P.60

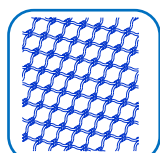

Tubonda

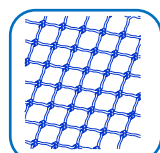

Tondino

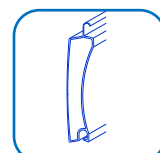

Coibentata DP.77



Coibentata DP.105

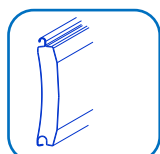

Coibentata DP.100

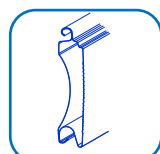

Coibentata DP.140

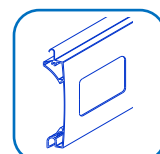

Finestrata

I contenuti delle schede tecniche sono indicativi e non impegnativi e in ogni caso saranno confermati dal nostro Ufficio Tecnico in fase di offerta o ordine.

Conegliano Serramenti s.r.l. può apportare modifiche, fermo restando le caratteristiche principali

### Conegliano Serramenti S.r.l.

Via Campolongo 1/E Loc.Ramera Z.I. / 31010 Marenò di Piave – Treviso - Italy

Tel: +39 0438.4985 Fax: +39 0438.498540 / Web site: [www.coneglianoserramenti.it](http://www.coneglianoserramenti.it) [www.forza-motion.com](http://www.forza-motion.com)

P.I. e C.F.: 00532460268- N.Reg.Imp.di TV 8758 / Capitale Sociale i.v.: € 78.000,00 – Capitale esistente al 31.12.15 € 78.000,00